

Manufacturer:
 PENDOCK, Halesfield 19, Telford, Shropshire, TF7 4QT.
T: 01952 580590 **E:** sales@pendock.co.uk **W:** www.pendock.co.uk

Product Range:
 Pendock Profiles

PENDOCK PROFILES
CASINGS FOR SERVICES

Product Reference:
 MXM-A-175-175 - Internal Fixing Angle

Product Description:
 The MXM range, with a single 90 degree return, is ideal for use on external applications or where services require protection from damage / vandalism / theft etc. The MXM profile can be positioned at corner vertical or horizontal locations including walls, ceiling, soffits, undercrofts, undersides of balconies, bulkheads, etc. Supplied in aluminium with a PPC finish as standard the MXM profile is non-combustible and weather resistant.

Size:
 175mm x 175mm profile section with one 90 degree angle. All sizes available - jointing / internal stiffening braces / sectional size and length subject to sheet size available, manual handling, transportation, ease of installation etc

Length:
 1000mm, 1250mm, 1500mm, 2000mm 2500mm, 3000mm & 4000mm lengths available as standard. Non-standard lengths also available upon request.

Thickness:
 2mm as standard - Other thickness available upon request

Profile Angle:
 90 degrees

Internal Working Space (approx):
 173mm x 173mm overall (2mm less than main casing dimensions)

Finish / Colour:
 Polyester Powder Coating (PPC)

Jointing:
 Butt Joint; Internal or External Butt Strap / Lining collar

Accessories:
 TEK Fixings (Colour coded if required)
 Stop Ends
 Butt Strap Joint Covers
 Fixing Angles
 Access Hatches
 Perforations

Drawing References:
 MXM-A-175-175

PLAN / SECTION DETAIL

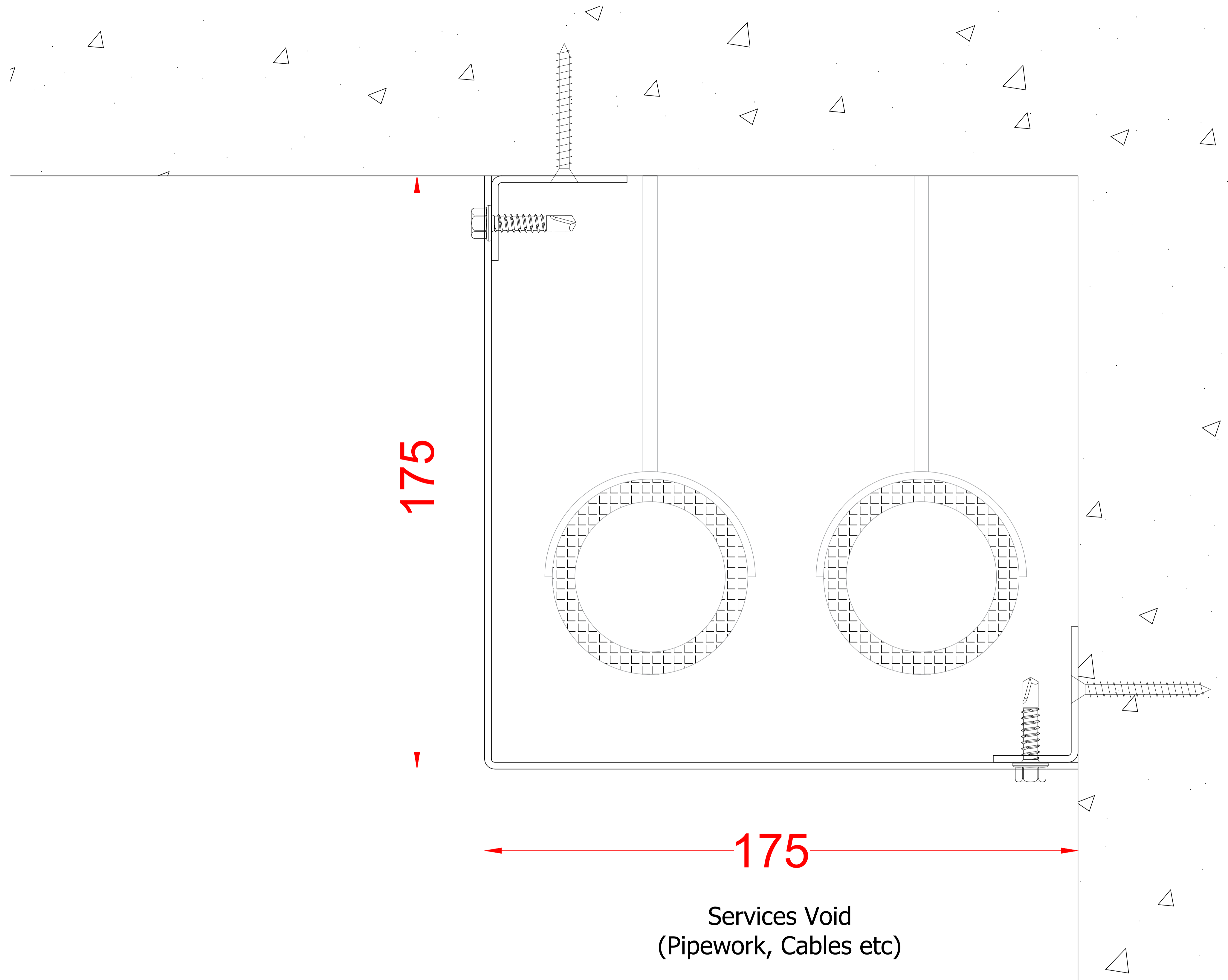

PRODUCT RANGE:	Pendock Profiles	
PRODUCT REF:	MXM-A-175-175	
DRAWING No:	MXM-A-175-175	
REVISION:		
CREATED:	03.07.2023	
DRAWN BY:	TECHNICAL DEPARTMENT	PAPER SIZE
DWG SCALE(S):	NTS	-
COLOUR / FINISH REF:	1.5-2mm Aluminium PPC to RAL	PROJECTION THIRD ANGLE

REV:	DATE:	REVISION:	INIT:
COPYRIGHT © 2020 ALL RIGHTS RESERVED - THIS DRAWING IS STRICTLY THE PROPERTY OF PENDOCK - (TP MANUFACTURING LTD)			

APPROVED BY:	
COMPANY:	
PRINT NAME:	
SIGNATURE:	
DATE:	

PENDOCK
THE CASING & ENCLOSURE SPECIALIST

HALESFIELD 19
 TELFORD
 SHROPSHIRE TF7 4QT
 (t) 01952 580590 (f) 01952 587805
 sales@pendock.co.uk
 www.pendock.co.uk