

**Manufacturer:**  
 PENDOCK, Halesfield 19, Telford, Shropshire, TF7 4QT.  
**T:** 01952 580590 **E:** sales@pendock.co.uk **W:** www.pendock.co.uk

**Product Range:** **PENDOCK PROFILES**  
 Pendock Profiles CASINGS FOR SERVICES

**Product Reference:**  
 MX 100x200x8mm

**Product Description:**  
 The MX range, with a single 90 degree return, is ideal for use at skirting level, ceiling level or vertically at corners to hide cables or pipework. Supplied in pre-formed plywood with white craft paper finish

**Size:**  
 100mm x 200mm angle section with one 90 degree angle.

**Length:**  
 2500mm

**Thickness:**  
 8mm

**Profile Angle:**  
 90 degrees

**Internal Working Space (approx):**  
 92mm x 192mm overall

**Finish / Colour:**  
 White craft paper

**Jointing:**  
 Butt Joint (see accessories)

**Accessories:**  
 Screws & White Caps  
 Internal Corners  
 External Corners  
 Stop Ends  
 Butt Joint Covers  
 Battens  
 Button Vents (white)  
 Access Hatches

**Drawing References:**  
 MX100x200x8mm

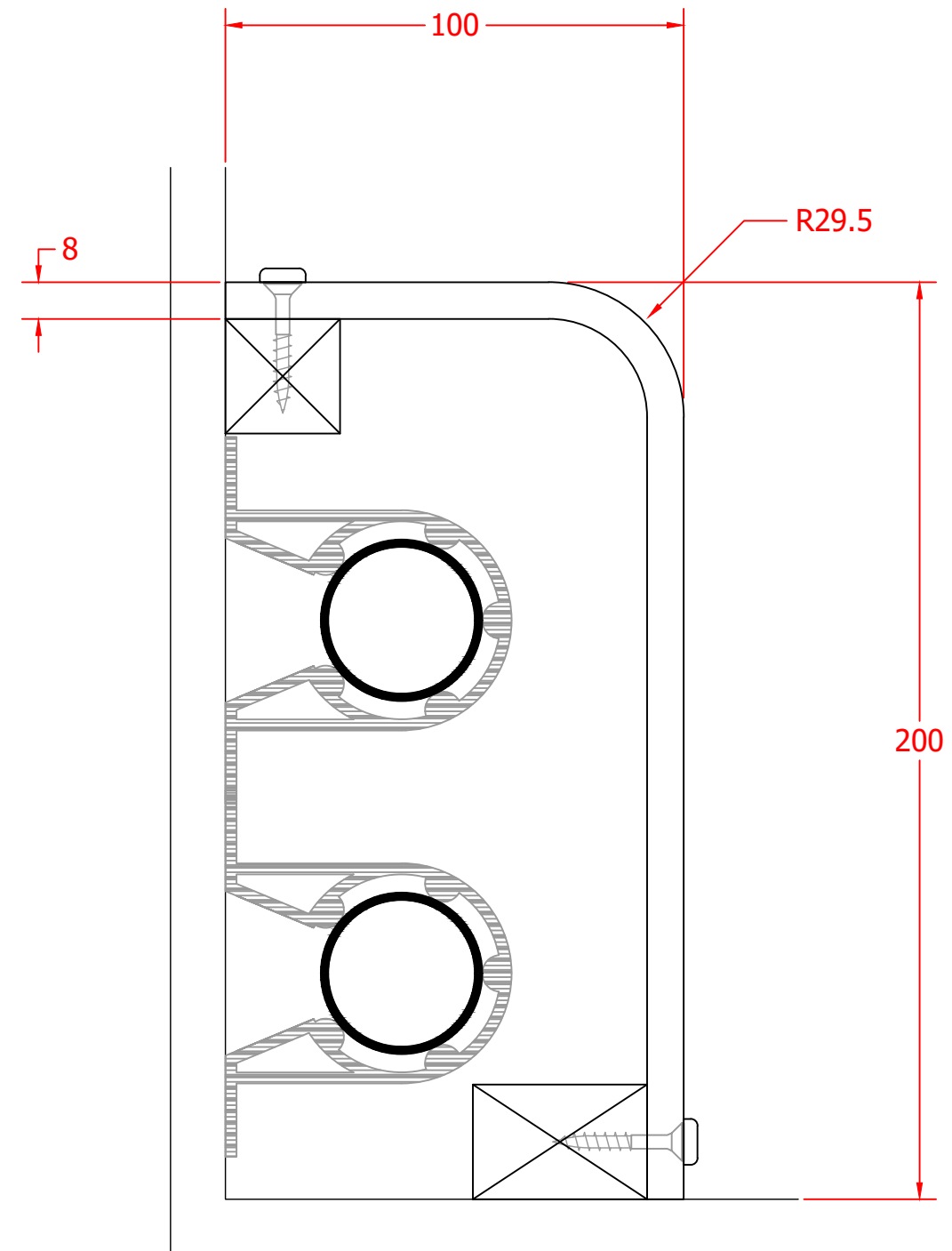

PRODUCT RANGE:	PENDOCK PROFILES		REV:	DATE:	REVISION:	INIT:	APPROVED BY:		
PRODUCT REF:	MX100x200x8mm						COMPANY:		
DRAWING No:	MX100x200x8mm						PRINT NAME:		
REVISION:	-						SIGNATURE:		
CREATED:	1.1.20						DATE:		
DRAWN BY:	TECHNICAL DEPARTMENT	PAPER SIZE							
DWG SCALE(S):	NTS								
COLOUR / FINISH REF:	WHITE CRAFT PAPER	PROJECTION THIRD ANGLE	COPYRIGHT © 2020 ALL RIGHTS RESERVED - THIS DRAWING IS STRICTLY THE PROPERTY OF PENDOCK - (TP MANUFACTURING LTD)						

**PENDOCK**  
THE CASING & ENCLOSURE SPECIALIST  
 HALESFIELD 19  
 TELFORD  
 SHROPSHIRE TF7 4QT  
 (t) 01952 580590 (f) 01952 587805  
 sales@pendock.co.uk  
 www.pendock.co.uk