

Manufacturer:
 PENDOCK, Halesfield 19, Telford, Shropshire, TF7 4QT.
T: 01952 580590 **E:** sales@pendock.co.uk **W:** www.pendock.co.uk

Product Range: **PENDOCK PROFILES**
 Pendock Profiles CASINGS FOR SERVICES

Product Reference:
 MX 75x300x8mm

Product Description:
 The MX range, with a single 90 degree return, is ideal for use at skirting level, ceiling level or vertically at corners to hide cables or pipework. Supplied in pre-formed plywood with white craft paper finish

Size:
 75mm x 300mm angle section with one 90 degree angle.

Length:
 2500mm

Thickness:
 8mm

Profile Angle:
 90 degrees

Internal Working Space (approx):
 67mm x 292mm overall

Finish / Colour:
 White craft paper

Jointing:
 Butt Joint (see accessories)

Accessories:
 Screws & White Caps
 Internal Corners
 External Corners
 Stop Ends
 Butt Joint Covers
 Battens
 Button Vents (white)
 Access Hatches

Drawing References:
 MX75x300x8mm

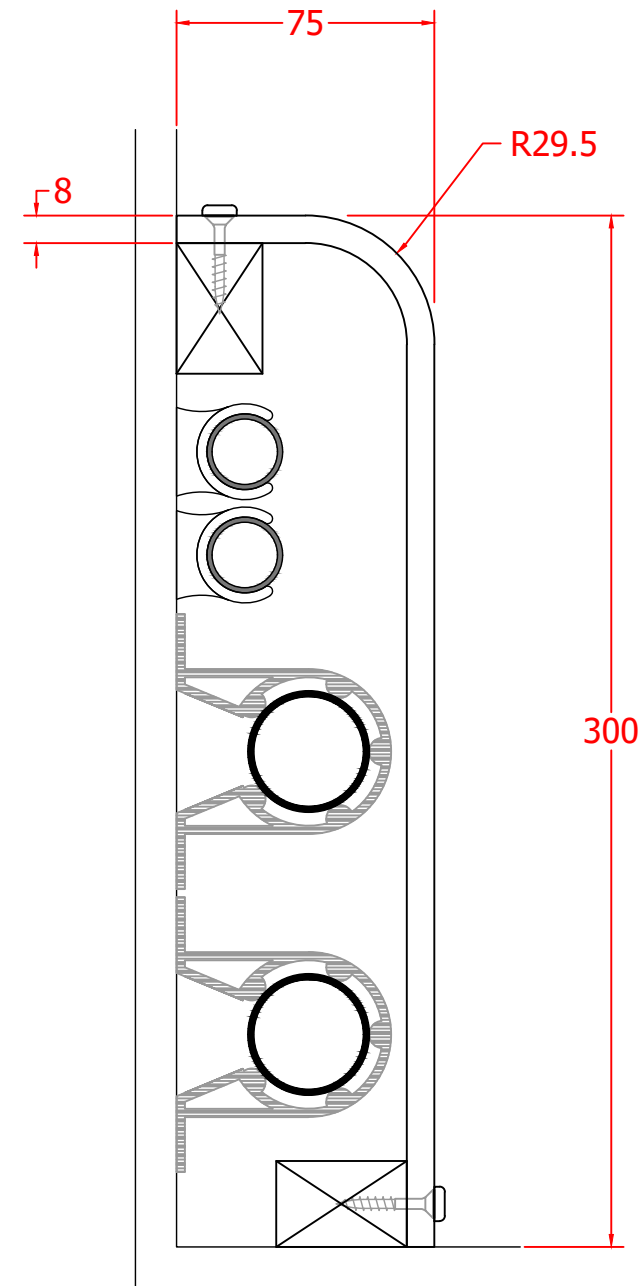

PRODUCT RANGE:	PENDOCK PROFILES	
PRODUCT REF:	MX75x300x8mm	
DRAWING No:	MX75x300x8mm	
REVISION:	-	
CREATED:	1.1.20	
DRAWN BY:	TECHNICAL DEPARTMENT	PAPER SIZE
DWG SCALE(S):	NTS	-
COLOUR / FINISH REF:	WHITE CRAFT PAPER	PROJECTION THIRD ANGLE

REV:	DATE:	REVISION:	INIT:
COPYRIGHT © 2020 ALL RIGHTS RESERVED - THIS DRAWING IS STRICTLY THE PROPERTY OF PENDOCK - (TP MANUFACTURING LTD)			

APPROVED BY:	
COMPANY:	
PRINT NAME:	
SIGNATURE:	
DATE:	

PENDOCK
THE CASING & ENCLOSURE SPECIALIST

HALESFIELD 19
 TELFORD
 SHROPSHIRE TF7 4QT
 (t) 01952 580590 (f) 01952 587805
 sales@pendock.co.uk
 www.pendock.co.uk